

# POWER CONTROLLER SPC SERIES

M A N U A L



Thank you very much for selecting Autonics products.  
For your safety, please read the following before using.

## Caution for your safety

- Please keep these instructions and review them before using this unit.
- Please observe the cautions that follow:
  - Warning** Serious injury may result if instructions are not followed.
  - Caution** Product may be damaged, or injury may result if instructions are not followed.
- The following is an explanation of the symbols used in the operation manual.
  - Warning** Injury or danger may occur under special conditions.

- In case of using this unit with machineries(Nuclear power control, medical equipment, vehicle, train, airplane, combustion apparatus, entertainment or safety device etc), it requires installing fail-safe device, or contact us for information on type required.**  
It may result in fatal damage, fire or human injury.
- This unit must be installed on panel and F.G. terminal must be a good earth ground.**  
It may give an electric shock.
- Do not connect terminals when it is power on.**  
It may give an electric shock.
- Do not disassemble and modify this unit, when it requires.**  
If needs, please contact us.  
It may give an electric shock and cause a fire.
- Do not touch terminals after power off.**  
It may give an electric shock.

- This unit shall not be used outdoors.**  
It might shorten the life cycle of the product or give an electric shock.
- Please see the wire spec. chart for power and load connection by load current.**  
It may give an electric shock.
- Please tighten bolt on terminal block with specified tightening torque.**  
Specified tightening torque  
-M3.5 : 0.6 to 1.2N · m(6.0 to 12.0kgf · cm)  
-M5 : 1.5 to 2.2N · m(15 to 25kgf · cm)  
It may cause a fire due to contact error.
- Please observe specification rating.**  
It might shorten the life cycle of the product and cause a fire.
- In cleaning the unit, do not use water or an oil-based detergent**  
It might cause an electric shock or fire that will result in damage to the product.
- Do not use this unit at place where there are flammable or explosive gas, humidity, direct ray of the sun, radiant heat, vibration, impact etc.**  
It may cause explosion.
- Do not inflow dust or wire dregs into inside of this unit.**  
It may cause a fire or mechanical trouble.
- Do not touch the heating panel while it is running.**  
It may cause a burn.

## Operation and function

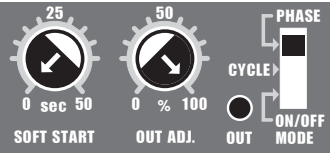

### 1. Control mode selection

Control mode	Phase control mode	Cycle control mode (Zero Cross)	ON/OFF control mode (Zero Cross)
Mode switch	PHASE ON/OFF	PHASE ON/OFF	CYCLE ON/OFF

\*The mode cannot be changed during it is operating.  
Please be sure to set the proper mode after cut the power off then apply the power again.

#### 1)Phase control

It is output type to control phase of an alternating according as control input signal.

(Picture 1)Equality division type of phase according as control input  
This is analog type to output control angle by dividing equally according as control input signal. It shows power characteristic as (Picture 1) and it might be occurred over power and lack power at point middle of control input.

(Picture 2)Equality division type of power according as control input  
It divides control angle non-equaly according as control input signal then make power curve linerize, so it becomes possible to output the power, which is proportioned control input as outputting (Picture 2).

\*To change a controlling method, please change JP3 of PCB as below.

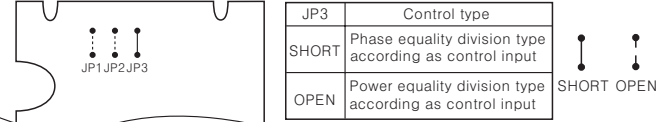

#### 2)Cycle control-Zero Cross

Control the applied power by ON/OFF cycle repetitively according to controlling input signal during set cycle(Selectable 0.5, 2, 10sec) as below. It is easy to control the load and there is no ON/OFF noise because it turns ON and OFF at the zero point of AC.  
Usually it is used in a place or electric furnace with not easily effected by external noise.

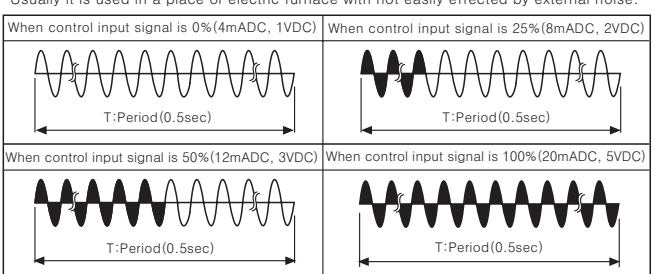

\*To control cycle, please change JP1 and JP2 of PCB as below.



\*The above specification are changeable without notice anytime.

## Ordering information

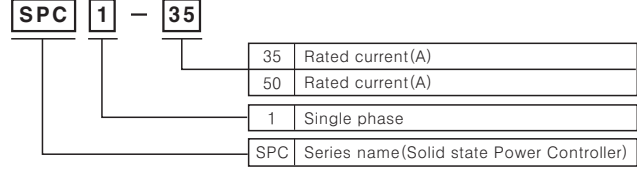

## Specifications

Model	SPC1-35	SPC1-50
Power supply	220VAC 50/60Hz	
Allowable operating voltage	90 to 110% of rated voltage	
Operating frequency fluctuation	±1Hz	
Maximum rated current	35A(Single phase)	50A(Single phase)
Control power	220VAC	
Control range	0 to 100%	
Applied load	Resistance load(Min. load:over 5% of rated current)	
Cooling method	Natural air cooling	
Control circuit	1-5VDC	
Control input	ON/OFF(External relay contact or 24VDC) External VR(1kΩ) Output limit input(Front OUT ADJ. VR)	
Control type	By selection S/W (Note 1)Phase control (Note 1)Cycle control(ZERO CROSS)-period(0.5, 2.0, 10sec) ON/OFF control(ZERO CROSS)	
Starting type	SOFT START(0 to 50 sec variable)	
Display	Output indication(LED)	
Insulation resistance	100MΩ (at 500VDC)	
Dielectric strength	2000VAC for 1 minute	
Noise	±2kV the square wave noise(pulse width:1μs) by the noise simulator	
Vibration	Mechanical	0.75mm amplitude at frequency of 10 to 55Hz in each of X, Y, Z directions for 1hour
	Malfunction	0.5mm amplitude at frequency of 10 to 55Hz in each of X, Y, Z directions for 10min.
Shock	Mechanical	300m/s <sup>2</sup> (30G) in X, Y, Z directions for 3 times
	Malfunction	100m/s <sup>2</sup> (10G) in X, Y, Z directions for 3 times
Ambient temperature	0 to 50°C (at non-freezing status)	
Storage temperature	-25 to 65°C (at non-freezing status)	
Ambient humidity	35 to 85%RH	
Weight	Approx. 1kg	

\* (Note 1)See <How to change additional function> in next page.

## Parts name

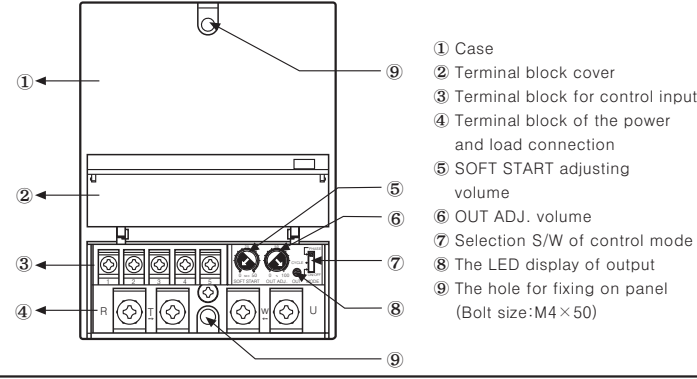

### 3)ON/OFF control-Zero Cross

This function is when control input is ON, output is 100%. When it is OFF, output is 0%. It is the same function as SSR(Solid State Relay). (On and Off is operated on the ZERO point of AC.) It is not able to use OUT ADJ. and SOFT START function in ON/OFF control mode.

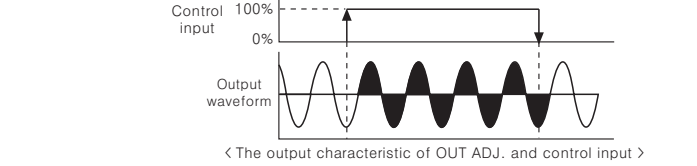

### 2. OUT ADJ. function(0 ~ 100%)

This function will be [Control input(%) X OUT ADJ.(%) = Output] and it controls the power applied to the load. Even if a control input is 100% (5V or 20mA), the output is the 50% of set value of OUT ADJ. when set value is 50%. When not using OUT ADJ. function, please make set value 100%.

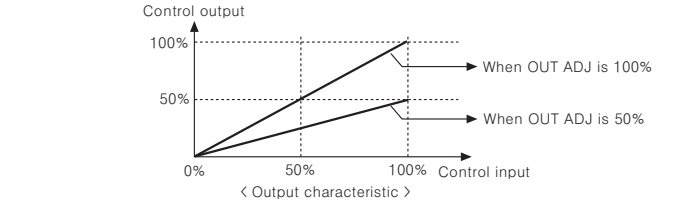

\* This function must not be used in ON/OFF control mode.

### 3. SOFT START function(0 ~ 50sec)

When the power is applied, this function is able to protect the load when it controls load (Molybdenum, White gold, infrared Lamp) with inrush current or the width of rising temperature in big(SV is big).

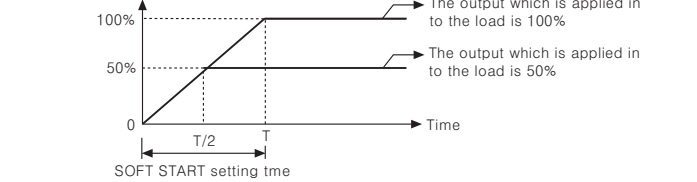

SOFT START set time (T) is the required time that output reaches to 100%, and it is differentiated by set value. For example, set a SOFT START as 10sec and set a OUT ADJ. as 70%, it takes 7sec. to reach goal output.  
[Set time (T) / OUT ADJ. set value (%) = 10sec/0.7 = 7sec]  
If increasing the OUT ADJ. before output reaches to goal output, it delays as much as the value, multiplying two of increased value (%) and SFT START set time.  
When not using SOFT START function, please make set value 0.  
\* This function must not be used in ON/OFF control mode.

### 4. OUT display function

This is LED ramp to display the status of output and will be getting brighter according as output (0%:LED illuminate Minimum, 100%:LED illuminate Maximum)

## Control input specification and function for each mode

Please see < Connection of control input terminals > and above function

Mode	Phase control mode	Cycle control mode	ON/OFF control mode
Input and function	DC4-20mA	1-5VDC	External relay contact or 24VDC
Control input specification	External relay contact	External volume	
Function	OUT ADJ.	SOFT START	OUT display

## Factory specification

Control mode	Phase control mode
Control type	Phase equality division type according as control input
SOFT START setting	0sec
OUT ADJ. setting	100%

\*The factory default for cycle control mode : 0.5sec

## Connection

### 1. External connection

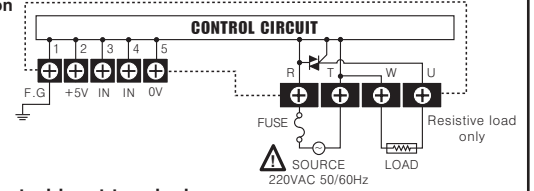

### 2. Connection of control input terminals

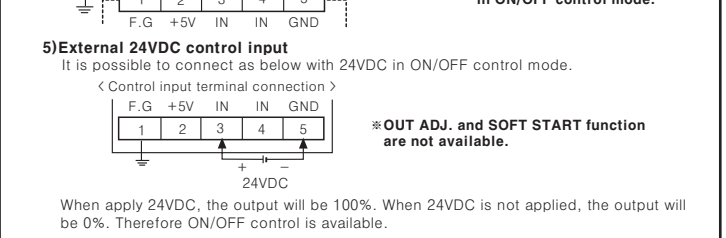
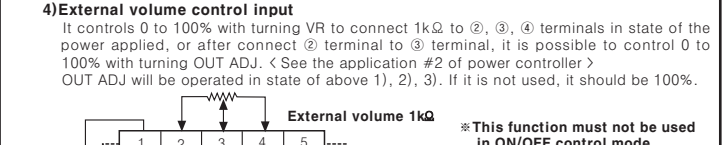
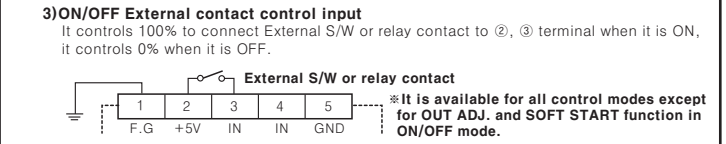
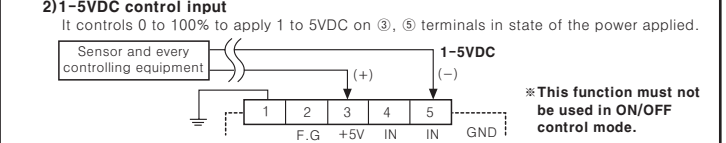
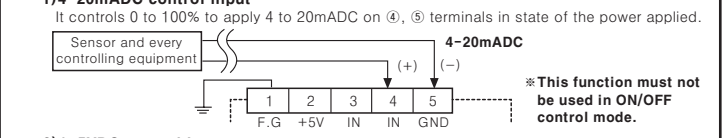

## Application

Ex1)When it needs to control accurately with adjusting the power in phase control and cycle control mode. For example, if need to control 80% output when it is ON, 24% output when it is OFF, please keep below.

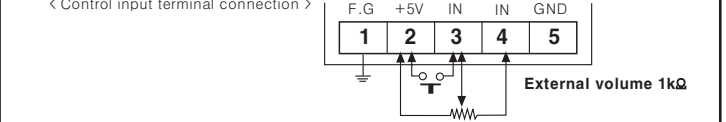

Ex2)This is how to control 0 to 100% without external volume in phase control mode and cycle control mode.

< Control input terminal connection >

It is possible to control 0 to 100% with turning OUT ADJ. in state of connecting terminal 2 and terminal 3.

## Dimensions

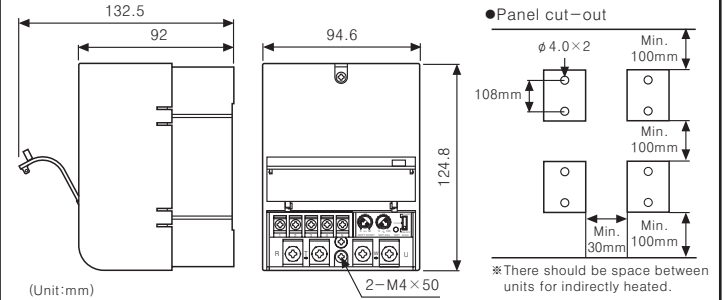

## Caution for using

- Installation environment
  - It shall be used indoor
  - Altitude Max. 2000m
  - Pollution Degree 2
  - Installation Category II.
- Do not use this unit at below places.
  - Place where there are severe vibration or impact.
  - Place where there are direct ray of the sun
  - Place where strong magnetic field or electric noise are generated.
- When test dielectric voltage and insulation resistance of the control panel with this unit installed.
  - Please isolate this unit from the circuit of control panel.
  - Please make all terminals of this unit short-circuited.
- When you install it on panel, it should be installed vertically at the place where is well ventilation. If install it horizontally, under 70% of rated current should be applied.
- The fuse for inner circuit must be installed between the terminal of R, T phase and the power.
- The inductive load must not be use because this is for resistive load only.
- The mode cannot be changed during it is operating. Please be sure to set the proper mode after cut the power off then apply the power again.

#### Wire specification by load current

AWG No.	Area(mm <sup>2</sup> )	Applicable current(A)
16	1.3mm <sup>2</sup>	Max. 10A
14	2.1mm <sup>2</sup>	Max. 15A
12	3.3mm <sup>2</sup>	Max. 20A
10	5.3mm <sup>2</sup>	Max. 30A
8	8.4mm <sup>2</sup>	Max. 40A
6	13.3mm <sup>2</sup>	Max. 55A

### 8. Case detachment

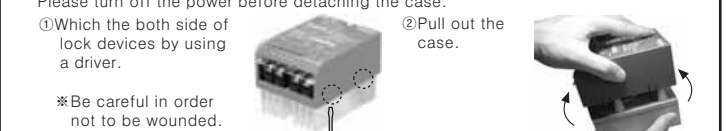

\*It may cause malfunction if above instructions are not followed.

## Main products

- COUNTER
- TIMER
- TEMPERATURE CONTROLLER
- PANEL METER
- TACHO/LINE SPEED/PULSE METER
- DISPLAY UNIT
- PROXIMITY SENSOR
- PHOTOELECTRIC SENSOR
- FIBER OPTIC SENSOR
- PRESSURE SENSOR
- ROTARY ENCODER
- SENSOR CONTROLLER
- POWER CONTROLLER
- STEPPING MOTOR & DRIVER & CONTROLLER
- LASER MARKING SYSTEM(CO<sub>2</sub>, Nd:YAG)

**Autonics Corporation**  
http://www.autonics.com

Satisfiable Partner For Factory Automation

HEADQUARTERS : 41-5, Yongdang-ri, Uingsang-eup, Yangsan-si, Gyeongnam, 626-847, Korea

INTERNATIONAL SALES : Bldg. 402 3rd Fl., Bucheon Techno Park, 193, Yakdae-dong, Wonmi-gu, Bucheon-si, Gyeonggi-do, 420-734, Korea  
TEL: 82-32-329-0722 / FAX: 82-32-329-0728  
E-mail : sales@autonics.net

EP-KE-10-0060D