

Rectangular Inductive Proximity Sensors

PS Series (AC 2-wire)

PRODUCT MANUAL

For your safety, read and follow the considerations written in the instruction manual, other manuals and Autonics website.

The specifications, dimensions, etc. are subject to change without notice for product improvement. Some models may be discontinued without notice.

Safety Considerations

- Observe all 'Safety Considerations' for safe and proper operation to avoid hazards.
- ⚠ symbol indicates caution due to special circumstances in which hazards may occur.

⚠ Warning Failure to follow instructions may result in serious injury or death.

- 01. Fail-safe device must be installed when using the unit with machinery that may cause serious injury or substantial economic loss. (e.g. nuclear power control, medical equipment, ships, vehicles, railways, aircraft, combustion apparatus, safety equipment, crime/disaster prevention devices, etc.)**
Failure to follow this instruction may result in personal injury, economic loss or fire.
- 02. Do not use or store the unit in the place where flammable/explosive/corrosive gas, high humidity, direct sunlight, radiant heat, vibration, impact, or salinity may be present.**
Failure to follow this instruction may result in explosion or fire.
- 03. Do not disassemble or modify the unit.**
Failure to follow this instruction may result in fire or electric shock.
- 04. Do not connect, repair, or inspect the unit while connected to a power source.**
Failure to follow this instruction may result in fire or electric shock.
- 05. Check 'Connections' before wiring.**
Failure to follow this instruction may result in fire or electric shock.

⚠ Caution Failure to follow instructions may result in injury or product damage.

- 01. Use the unit within the rated specifications.**
Failure to follow this instruction may result in fire or product damage.
- 02. Use a dry cloth to clean the unit, and do not use water or organic solvent.**
Failure to follow this instruction may result in fire or electric shock.
- 03. Do not supply power without load.**
Failure to follow this instruction may result in fire or product damage.

Cautions during Use

- Follow instructions in 'Cautions during Use'. Otherwise, it may cause unexpected accidents.
- Wire as short as possible and keep away from high voltage lines or power lines, to prevent surge and inductive noise. Do not use near the equipment which generates strong magnetic force or high frequency noise (transceiver, etc.). In case installing the product near the equipment which generates strong surge (motor, welding machine, etc.), use diode or varistor to remove surge.
- Do not connect capacity load to the output terminal directly.
- This unit may be used in the following environments.
 - Indoors (in the environment condition rated in 'Specifications')
 - Altitude max. 2,000 m
 - Pollution degree 2
 - Installation category II

Cautions for Installation

- Install the unit correctly with the usage environment, location, and the designated specifications.
- The waterproof function may be damaged if the product is subjected to impact from a hard object or bent excessively or repeatedly.
- Do NOT pull the $\varnothing 2.5$ mm cable with a tensile strength of 20 N, the $\varnothing 4$ mm cable with a tensile strength of 30 N or over and the $\varnothing 5$ mm cable with a tensile strength of 50 N or over. It may result in fire due to the broken wire.
- When extending wire, use AWG 22 cable or over within 200 m.
- Tighten the installing screw with under 0.59 N m tightening torque when mounting the bracket.

Ordering Information

This is only for reference, the actual product does not support all combinations.
For selecting the specified model, follow the Autonics website.

PSN ① - ② ③ ④

① Sensing side length

Number: Side length of head (unit: mm)

③ Power supply

A: 100 - 240 VAC

② Sensing distance

Number: Sensing distance (unit: mm)

④ Control output

O: Normally Open
C: Normally Closed

Product Components

	PSN25	PSN30	PSN40
Product	× 1	× 1	× 1
Instruction manual	× 1	× 1	× 1
Bracket	× 1	× 1	× 1
Bolt	M4 × 2	M4 × 2	M5 × 2

Connection

- LOAD can be wired to any direction.
- Connect LOAD before supplying the power.

■ Cable type

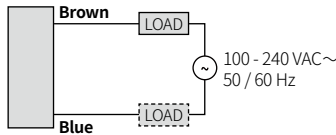

■ Inner circuit

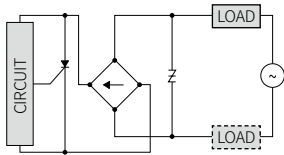

Operation Timing Chart

	Normally open	Normally closed
Sensing target	Presence Nothing	Presence Nothing
Load	Operation Return	Operation Return
Operation indicator (red)	ON OFF	ON OFF

Specifications

Installation	Standard type			
Model	PSN25-5A□	PSN30-10A□	PSN30-15A□	PSN40-20A□
Sensing side length	25 mm	30 mm	30 mm	40 mm
Sensing distance	5 mm	10 mm	15 mm	20 mm
Setting distance	0 to 3.5 mm	0 to 7 mm	0 to 10.5 mm	0 to 14 mm
Hysteresis	≤ 10% of sensing distance			
Standard sensing target: iron	25 × 25 × 1 mm	30 × 30 × 1 mm	45 × 45 × 1 mm	60 × 60 × 1 mm
Response frequency ⁰¹⁾	20 Hz			
Affection by temperature	± 10% for sensing distance at ambient temperature 20 °C			
Indicator	Operation indicator (red)			
Certification	CE 标志	CE 标志	CE 标志	CE 标志
Unit weight (package)	≈ 66 g (≈ 98 g)	≈ 92 g (≈ 161 g)	≈ 92 g (≈ 161 g)	≈ 130 g (≈ 219 g)

01) The response frequency is the average value. The standard sensing target is used and the width is set as 2 times of the standard sensing target, 1/2 of the sensing distance for the distance.

Power supply	100 - 240 VAC ~ 50 / 60 Hz, operating voltage: 85 - 264 VAC ~
Leakage current	≤ 2.5 mA
Control output	5 to 200 mA
Residual voltage	≤ 10 V
Protection circuit	Surge protection circuit
Insulation type	≥ 50 MΩ (500 VDC = megger)
Dielectric strength	Between the charging part and the case: 1,500 VAC ~ 50/60 Hz for 1 min
Vibration	1 mm double amplitude at frequency 10 to 55 Hz in each X, Y, Z direction for 2 hours
Shock	500 m/s ² (≈ 50 G) in each X, Y, Z direction for 3 times
Ambient temperature	-25 to 70 °C, storage: -30 to 80 °C (no freezing or condensation)
Ambient humidity	35 to 95 %RH, storage: 35 to 95 %RH (no freezing or condensation)
Protection rating	IP67 (IEC standards)
Connection	Cable type model
Wire spec.	Ø 4 mm, 2-wire, 2 m
Connector spec.	AWG 22 (0.08 mm, 60-core), insulator diameter: Ø 1.25 mm
Material	Case: Heat-resistant ABS, standard type cable (black): polyvinyl chloride (PVC)

Dimensions

• Unit: mm, For the detailed drawings, follow the Autonics website.

A	Operation indicator (red)	B	Tap hole
---	---------------------------	---	----------

■ PSN25

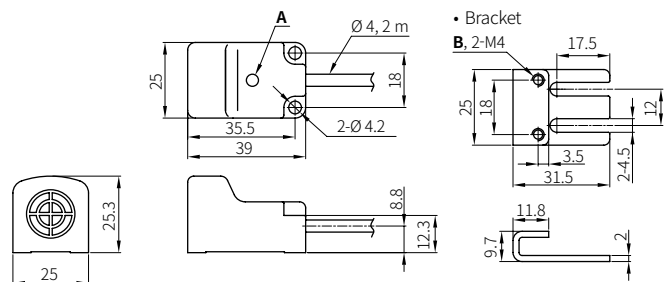

■ PSN30

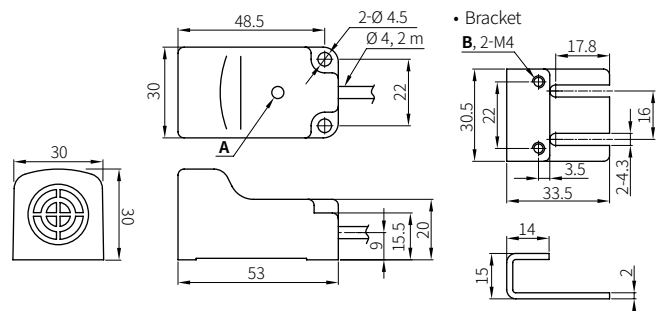

■ PSN40

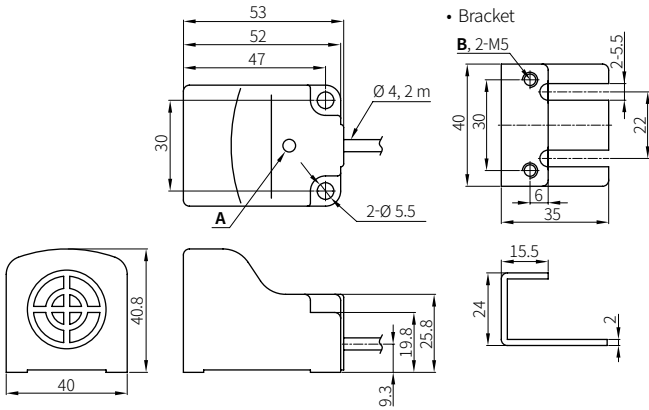

Setting Distance Formula

Detecting distance can be changed by the shape, size or material of the target. For stable sensing, install the unit within the 70 % of sensing distance.

Setting distance (Sa)
= Sensing distance (Sn) × 70 %

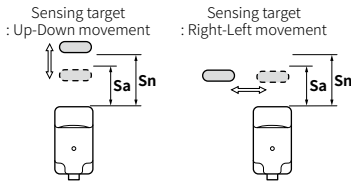

Mutual-interference & Influence by Surrounding Metals

■ Mutual-interference

When plural proximity sensors are mounted in a close row, malfunction of sensor may be caused due to mutual interference. Therefore, be sure to provide a minimum distance between the two sensors, as below table.

[Face to Face]

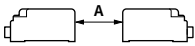

[Parallel]

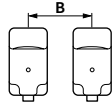

■ Influence by surrounding metals

When sensors are mounted on metallic panel, it must be prevented sensors from being affected by any metallic object except target. Therefore, be sure to provide a minimum distance as below chart.

• Standard type

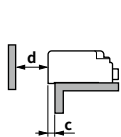

• Upper side type

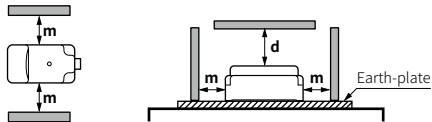

(unit: mm)

Model	PSN25	PSN30-10	PSN30-15	PSN40
A	30	60	90	120
B	40	50	65	70
c	4	5	5	5
d	15	30	45	60
m	20	25	35	35

Sensing Distance Feature Data by Target Material and Size

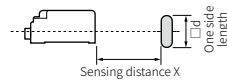

• PSN25

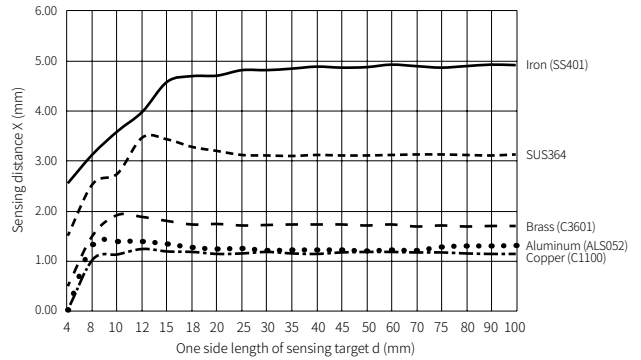

• PSN30-10

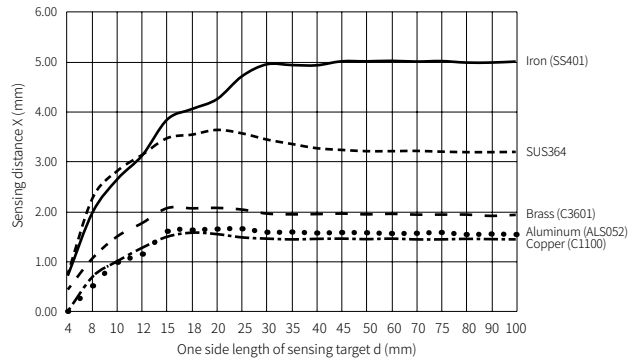

• PSN30-15

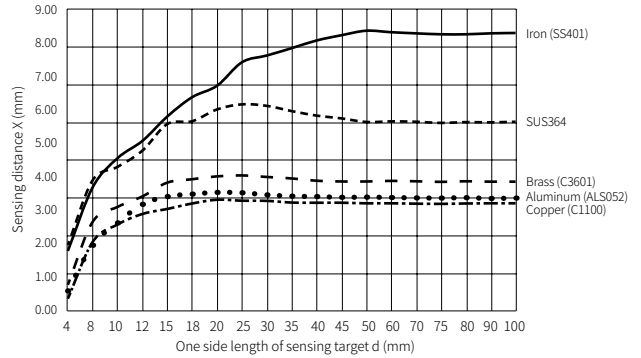

• PSN40

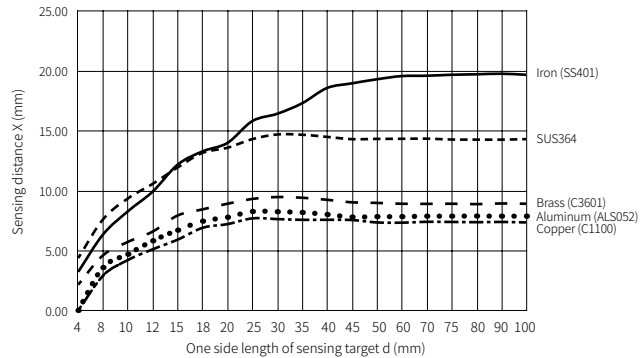

Sensing Distance Feature Data by Parallel (Left/Right) Movement

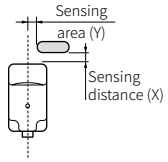

• PSN25

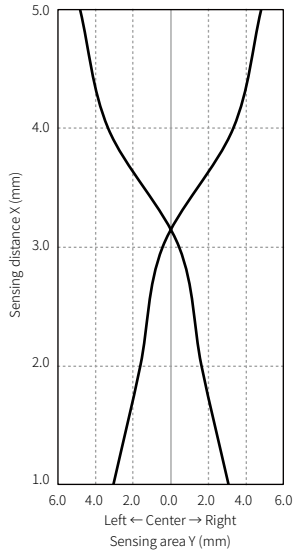

• PSN30

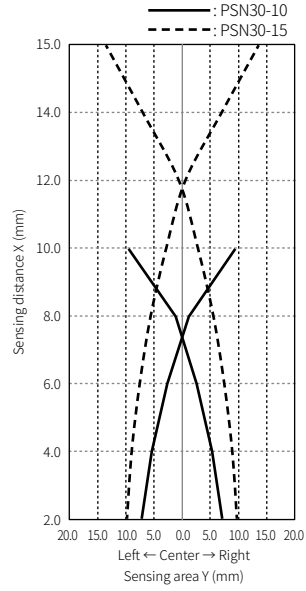

• PSN40

